

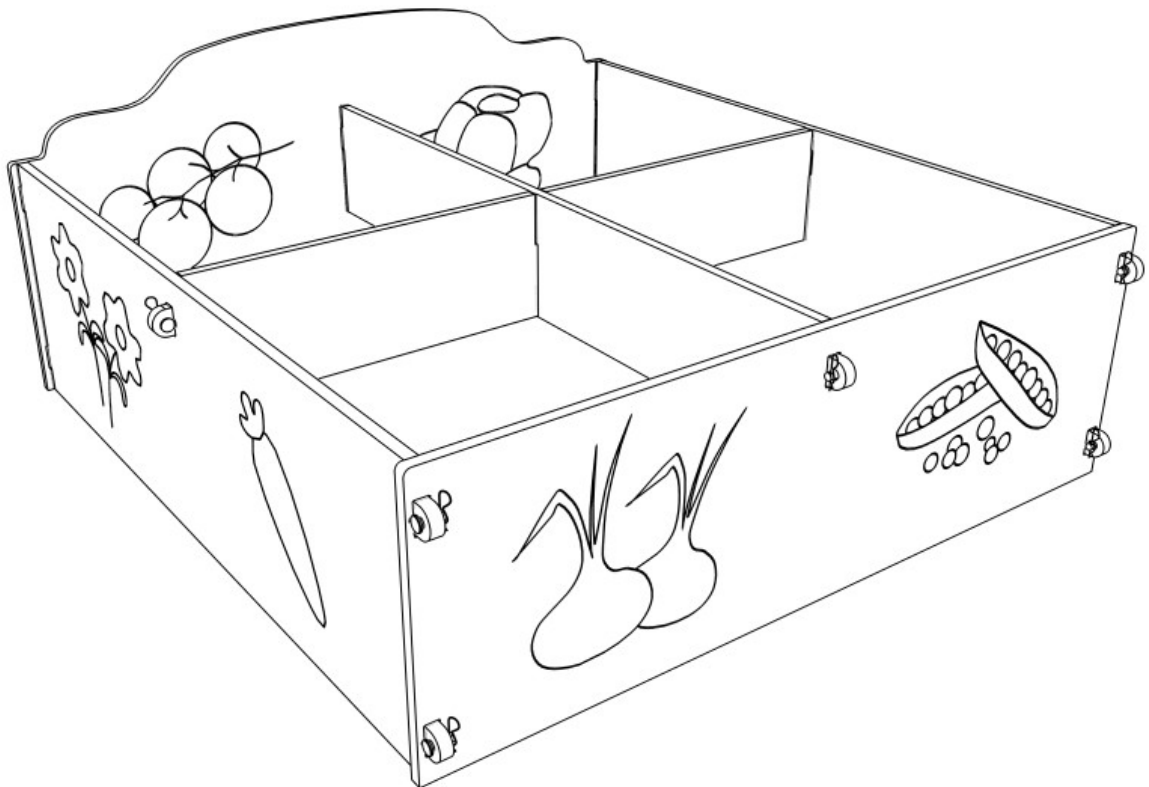

HOW TO ASSEMBLE, USE AND CARE FOR YOUR Square Foot Garden (Small)



RECYCLED & RECYCLABLE

Products from green frog designs are made, wherever possible, from materials that are recycled. Where this is not practical, we always try to use materials that are suitable for recycling.

Our plastic is made from recycled waste plastic, predominantly plastic wrapping and carrier bags. By choosing our products, rather than those made from virgin plastic, you are helping to restrict the amount of new plastic being made. We recycle all our waste plastic and, of course, our products themselves can be recycled (if they ever wear out!!).

The recycled plastic we use is incredibly tough, but is as easily worked as wood. There is no need for preservative treatment with insecticides or fungicides, and structures won't splinter or crack, so they retain their structural integrity well. The plastic is resistant to UV light, so it retains its colour well, and is pretty much impervious to atmospheric pollutants and seasonal climatic actions such as freeze-thaw. It insulates quite well, and is also resistant to chewing. These properties mean that it retains its appearance, colour and functionality for much longer than timber.

The sheets of recycled plastic have a very uniform thickness, and so are ideally suited to our high-technology manufacturing process, which uses computer-controlled machines to cut shapes to accuracies better than 0.1mm.

We also use some metal components to fix parts together. The metals used are either stainless steel or other rust-resistant alloy, so they have a very long lifetime. They are also suitable for recycling.

Our packaging and literature is all made from recycled materials wherever possible. For example, assembly instructions are printed on recycled paper, and we use recycled plastic bubble-wrap in our packaging. Even our business cards are made from 80% recycled card.

In other words: **Fun, functional products that don't cost the Earth!**



HOW TO FIT A CLEVIS PIN (IF USED)

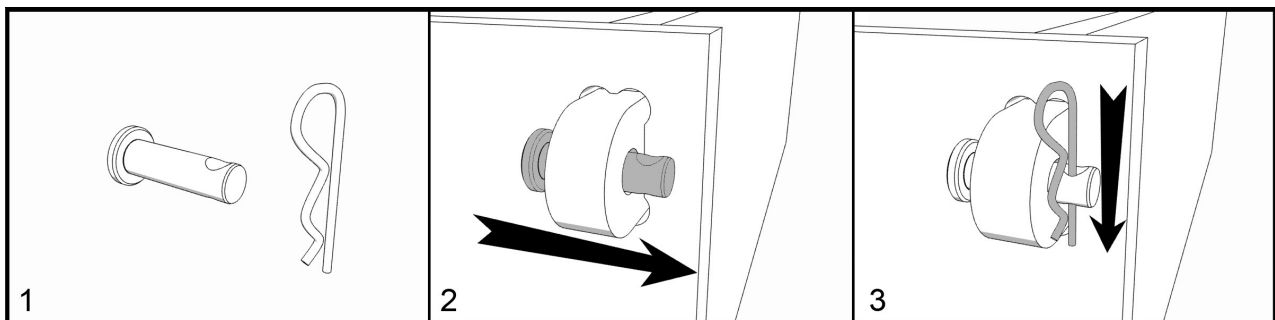

HOW TO FIT A LINCH PIN (IF USED)

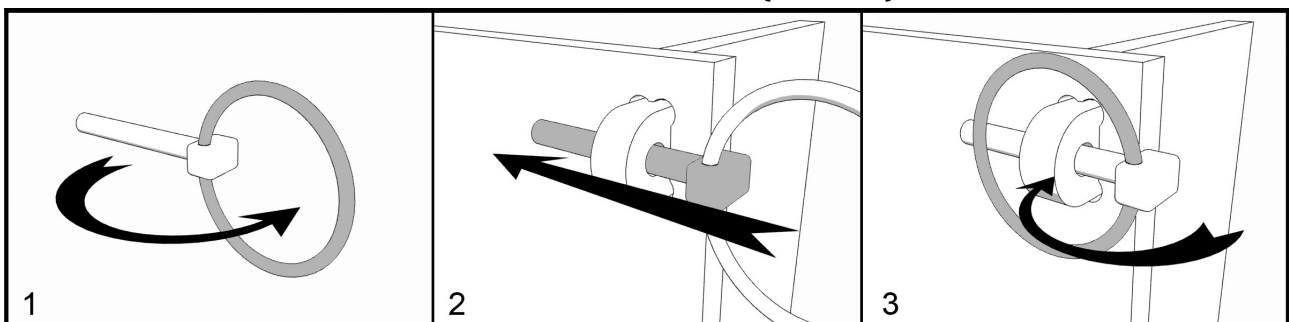

Linch Pins are designed to spring closed, so watch your fingers!

PARTS

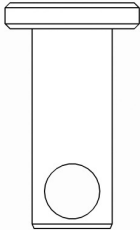
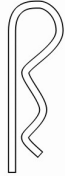
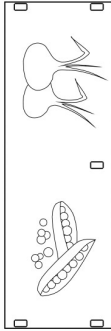
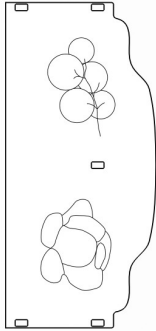
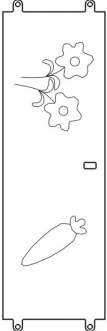
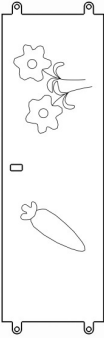
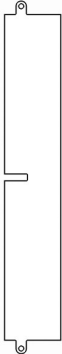
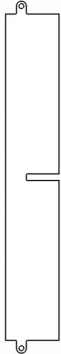
									
12x	Medium Clevis Pin	12x	R-Clip	1x	Front Wall	1x	Back Wall	1x	Left Wall
									
1x	Right Wall	1x	Centre Wall A	1x	Centre Wall B				

If any parts are missing, please email sales@greenfrogdesigns.co.uk
Please state the part number, quantity missing, your phone number and your full postal address.

DIMENSIONS

Dimensions: 62 [w] x 28 [h] x 65 [d] cm

TOOLS REQUIRED

Sharp knife [e.g. Stanley Knife] or Sand Paper

Prior to assembly, check all parts and trim any excess plastic using sand paper or a sharp knife.
(NOTE: Be careful to cut away from yourself.)

HOW TO ASSEMBLE

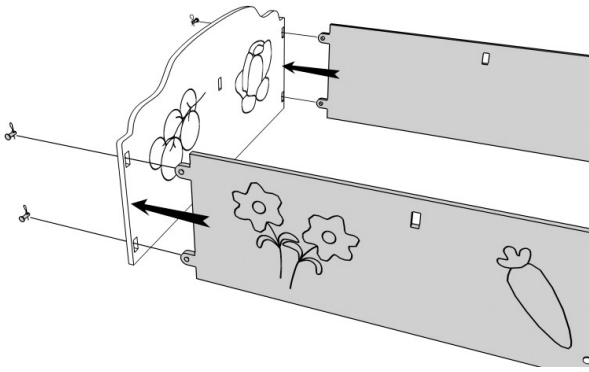
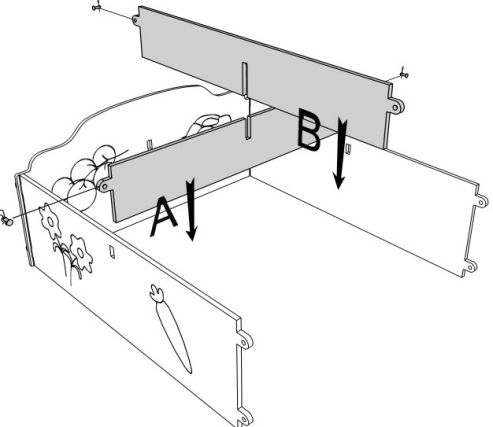
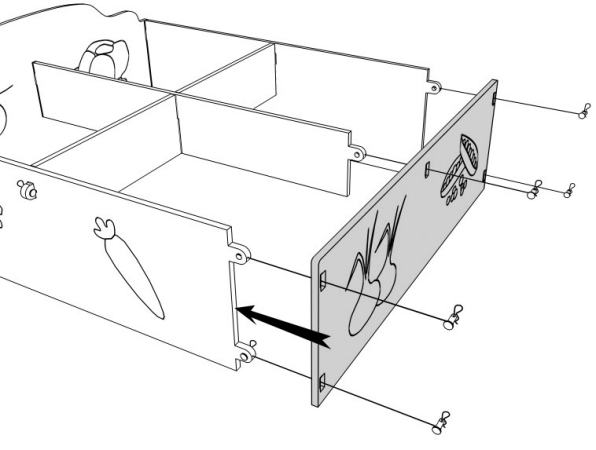
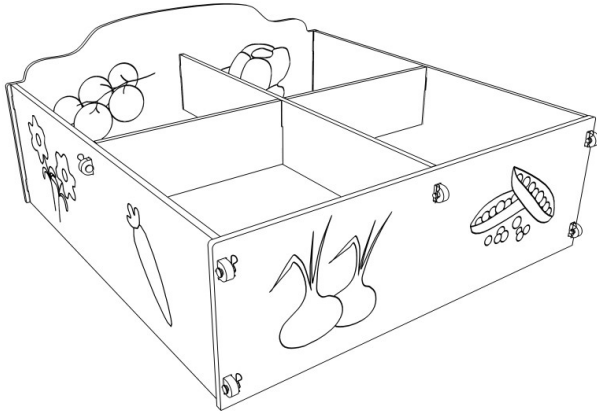
	
<p>1 Slide the Left and Right Walls onto the Rear Wall as shown, and secure with Medium Clevis Pins and R-Clips. The Side Walls should face pattern outwards, and the Rear Wall pattern inwards.</p>	<p>2 Fit Centre Wall A and then Centre Wall B to the Side and Back Walls as shown. Flex the Side Walls out slightly to allow insertion of the lugs, and then secure with Medium Clevis Pins and R-Clips.</p>
	
<p>3 Attach the Front Wall (Pattern outermost) with Medium Clevis Pins and R-Clips.</p>	<p>4 You're finished, but please continue reading for more information about square foot gardens.</p>

SQUARE FOOT GARDEN INFORMATION

Perfect for introducing children to gardening, for those new to growing veg, and for gardeners with limited space. Using a square foot garden, you can manage a small area for maximum productivity.

The square foot garden is a raised bed that is divided into areas of one square foot. You plant a single type of vegetable or flower into each section. The concept was started about 25 years ago in the USA by Mel Bartholomew.

Our larger square foot gardens also have two or three deeper sections for veg, such as carrots, that need additional soil depth. Taller plants are usually grown at the back and in the middle. The sections are easily reached from the side, so the soil is never compacted.

Each section is planted with a different crop, and the seeds or seedlings are very closely spaced. As soon as each crop is harvested, it is replaced by another.

The garden can be sited pretty much anywhere, even on a patio, balcony or concrete floor, but ideally with a good southerly exposure.

For more information, including planting schemes, search on the Internet for "Square Foot Gardens". Sites you may find useful include:

<http://www.squarefootgardening.com/>

http://www.gardenorganic.org.uk/organicgardening/gh_sqft.php