

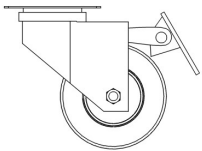

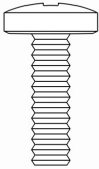





Carry Box Wheel Kit

				
2x Swivel Castor	2x Fixed Castor	16x M6x20mm Screw	16x Nylock Nut	32x Standard Washer
				
2x Wheel Plate	2x Short Clevis Pin	2x R-Clip		

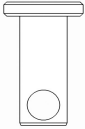

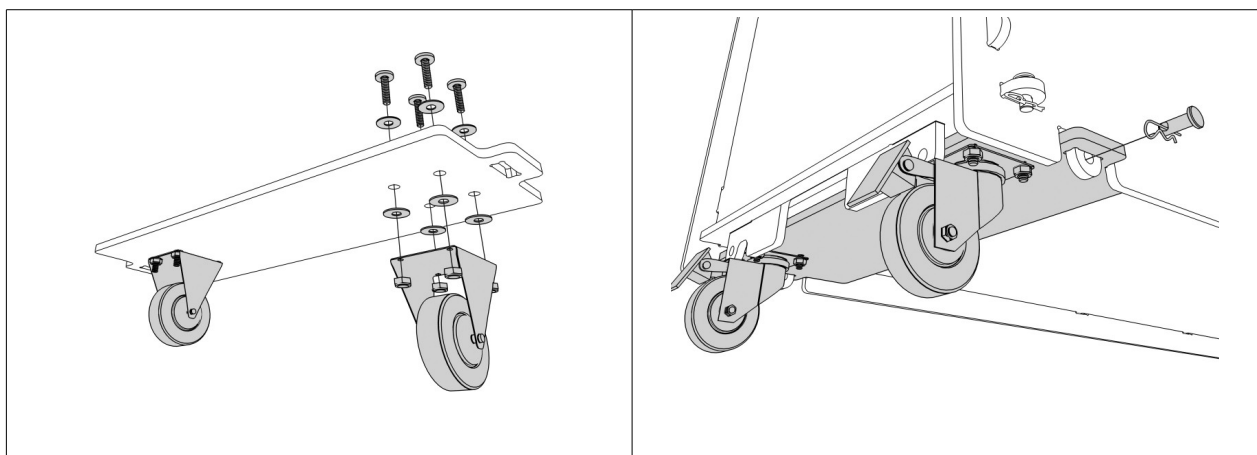
- 1 Castors are bolted to the **Wheel Plates** using **20mm Screws, Standard Washers** and **Nylock Nuts**. Each **Wheel Plate** has holes suitable for either set of wheels. One pair must be **Fixed Castors**, the other must be **Swivel Castors**. The nuts **must** be on the bottom (i.e. the wheel side) with **washers** either side of the **Wheel Plates**.
- 2 Fix the **Wheel Plates** to the base using **Short Clevis Pins** and **R-Clips**. The **Wheel Plate** with the **Swivel Castors** should be fitted so that the wheels are nearest the end of the **Carry Box** (or the brake levers will be inaccessible).